

ENGLISH

2 WIRE INTERCOM SYSTEM

USER MANUAL

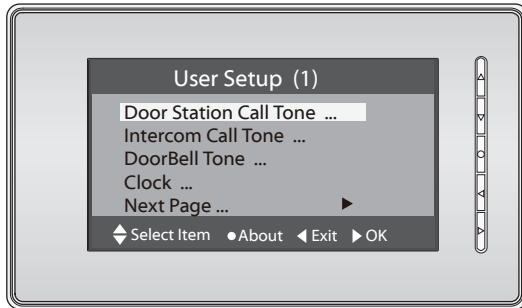

DT-ENG-DT10D7-V1

1. Parts and Functions

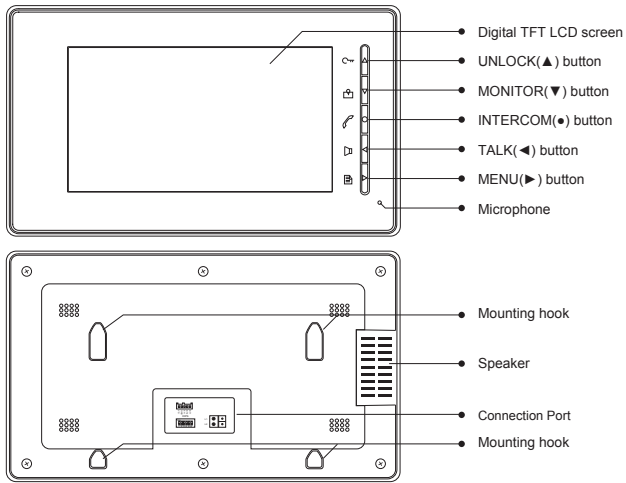

2. Monitor Mounting

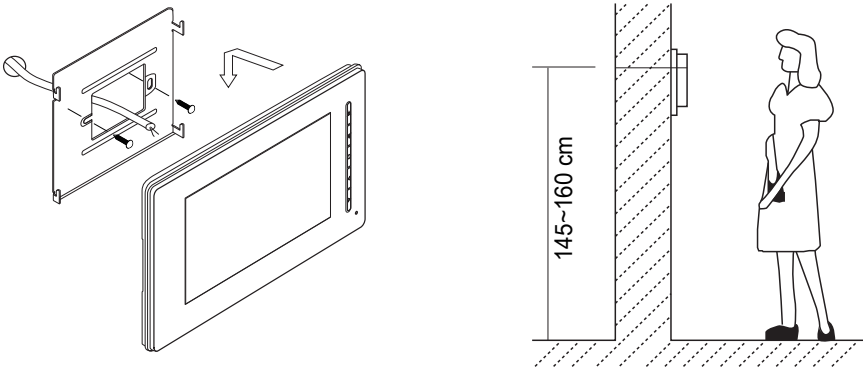

1. Use the screws to fix the Mounting Bracket on the mounting box.(fitting accesories includes a Bracket (Two pieces of 4X25 screws are needed for fastening the Mounting Bracket), Special 2 wire cables to connect with Monitor)
2. Wire the system correctly(see the later connection chapter) then hang the Monitor on the Mounting Bracket firmly.

3. Basic Door Release Operation

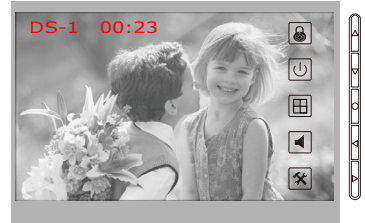

1. Press **CALL** button on outdoor station, the Monitor rings, at the same time, the screen displays the visitor image.
2. Press **TALK** (◀) button on monitor, you can communicate hands free with the visitor for 90 seconds. After finishing communication, press "TALK" button again to end the communication. If nobody answers the phone, the screen will be turned off automatically after 30 seconds.
3. During talking state, Press **UNLOCK** (▲) button to open the door for the visitor. If two locks are connected to door camera, press corresponding unlock button to open the matching door.
4. When the monitor is in standby mode, press **MONITOR** (▼) , the screen can display the view of outside. If multi door stations are installed, press **INTERCOM** (●) button to enter camera switch mode. Select **Camera 1 ...** item, the screen will display the image from the first door camera. Similarly. Select **Camera 2 ...** item to choose the second one. Select **Camera 3 ...** item to choose the third one. Select **Camera 4 ...** item to choose the fourth one. (Press "MONITOR" button again to end monitoring.)

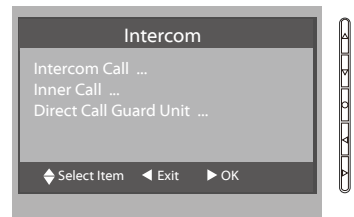

4. Intercom Function

When the monitor is in standby mode, press **INTERCOM** (●) button to enter Intercom Function page. Use ▲ / ▼ button to move upward / downward to select the item you want, press **MENU** (▶) button to confirm.



Intercom Call: User in one apartment can call other apartments in the system. the namelist will be created automatically by the system. Selete a name on the screen then press  **MENU** () button to dial.(Note:1. Press "MENU " button again to redial. 2.The DIP switches code of each monitor must set different.)







Inner Call: If multi Monitors are installed in the same apartment, select Inner Call, all the other Monitors will ring at the same time, whichever Monitor answers the call, conversation is started.and the other monitors will stop ringing at the same time.(note:the DIP switches setting of all monitors must be same.)

Direct Dial Guard unit: A Monitor can be assigned as Guard Unit Monitor; when the Guard Unit Monitor answers the call, conversation with the guard person is started..

5. Basic Setup Instructions

Ring Tone Settings

Select **Door Station Call Tone**, **Inercom Call Tone** or **DoorBell Tone** item on User Setup (1) page, There are 12 pieces ring tones can be selected.use  /  Button to select last/next ring tone, press  **MENU** () button to save and exit.

*Door Station Call Tone:*set the ring tone calling from outdoor station.

*Intercom Tone:*set the ring tone calling from other apartments.

*DoorBell tone:*set the ring tone calling from door bell.

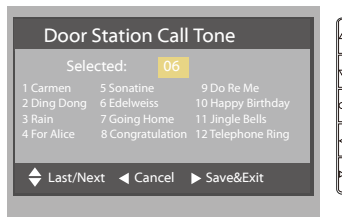
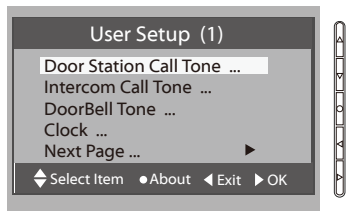

6. Date and Time Setting

Select *Clock...* item on User Setup (1) page. Input date and time by pressing ▲ / ▼ button to increase / decrease the value; press ◀ / ▶ button to select last/next digit. After finish, press ⌘ INTERCOM (●) button to save and return last page.

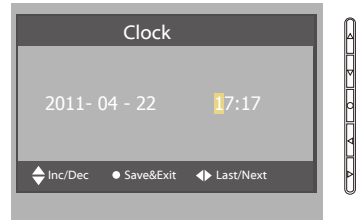

7. Monitor Time setting

Select **Manual Monitor** item on main menu page, then select *Monitor Time Set...* item. Use ▲ / ▼ Button to increase / decrease the value; After finish, press ⌘ INTERCOM (●) button to save and return last page.

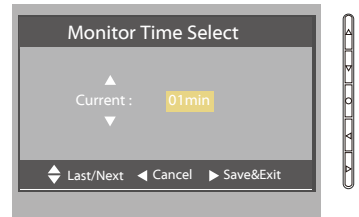

8. Monitor Installation Setting

How to enter the installation setting page

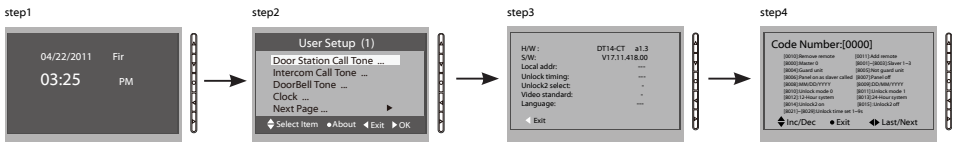

1. Press MENU (▶) button in standby mode. A calendar will be showed, then press MENU button again.
2. Press ⌘ INTERCOM (●) button at User Setup (1) page to enter About information page.
3. Press UNLOCK (▲) button and hold for 2s.
4. Press ▲ / ▼ button to increase/decrease the value and ◀ / ▶ button to select the setting number ,press MENU (▶) to save the settings after inputing 4 digits number, press ● button to return last page.

How to set the monitor panel on

In default mode,when receive a calling,the master and slave monitors will ring at the same time,and just the master monitor can display the image while the slave monitors can not.But the settings can be changed,you can set the master monitor and all the slave monitors to panel on at the same time when receiving a call, just input the code number of 8006 on each slave monitor.

How to set the unlock parameter

Unlock mode:

There are two unlock modes: 1.power-on- to-unlock type:unlock mode=0(by default)
2.power-off-to-unlock:unlock mode=1.

The code number of 8010 is used to set the unlock mode to 0

The code number of 8011 is used to set the unlock mode to 1

Unlock time:

The unlock time can be changed by yourself at any time.it can be set from 1 to 9 seconds.

The code number from 8021 to 8029 are used to set the unlock time to 1~ 9 seconds.

2 locks control

The monitor can be set to control 2 locks while you should set the unlock2 item to "on " state.

The code number of 8015 is used to set the unlock2 off that it can only control one lock.

The code number of 8014 is used to set the unlock2 on that it can control two locks.

Note:1. During talking or monitoring state, press $\text{C}\rightarrow$ UNLOCK (\blacktriangle) button,two unlock icons will be showed. press $\text{C}\rightarrow$ UNLOCK (\blacktriangle) button to release the first lock, press $\text{C}\rightarrow$ MONITOR (\blacktriangledown) to release the second lock,press $\text{C}\rightarrow$ INTERCOM (\bullet) button to return last page.

2. Restore to default operation will not chang the parameters setting.

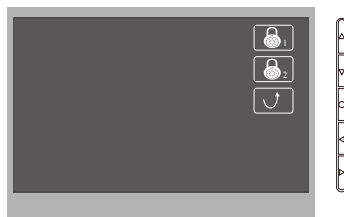

How to set the menu language

The monitor can support multi languages and it is so simple and fast, just input the corresponding language code on monitor. The language code number are as follows:

8101: English	8107: Portuguese	8113: Russian
8102: French	8108: S-Chinese	8114: Slovakia
8103: Spanish	8109: T-Chinese	8115: Hungary
8104: Italian	8110: Greek	8116: Czech
8105: German	8111: Turkish	
8106: Dutch	8112: Polish	

Note: the monitor can only support 4 types of languages. English, French, Spanish and German are default. But you can customize any 4 languages by yourself. The language which is unavailable will be set to English in default.

9. Screen and Volume Adjustment

During monitoring or talking, press MENU Button, the *ADJUST MENU* will be displayed.

Press ▲ / ▼ button to select the adjustment item; press ◀ / ▶ button to decrease / increase the value.

1. The first item is Scene mode selection: Total 4 screen modes can be selected in sequence: *Normal*, *User*, *Soft* and *Bright*. Whenever you modify *Brightness* or *colour*, *Scene* item will be set to *User* mode automatically.
2. The *Brightness* and *Colour* item is for the image quality setting, adjust the value to get the best image you like.
3. The *Ring Volume* and *Talk Volume* items are ring tone and talking volume adjustment.
4. Note that all the modifications will be done immediately after the operation. Press "MENU" button to quit the adjust page.

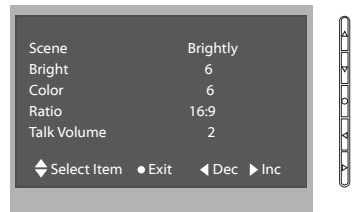

10. Specification

- Power supply for indoor monitor: DC 24V
- Power consumption: Standby 0.5W; Working status 5W
- Monitor screen: 7 Inch digital TFT LCD
- Display Resolutions: 800*3(RGB)*480 pixels
- Video signal: 1Vp-p, 75Ω, CCIR standard
- Wiring: 2 wires, non-polarity
- Dimension: 143(H)×242(W)×23(D) mm

DT-ENG-DT10D7-V1

The design and specifications can be changed without notice to the user. Right to interpret and copyright of this manual are preserved.