

DT25TD5

Indoor Monitor

User Manual



Please read this manual carefully before using the product you purchase, and keep it well for future use. We reserve the right to modify the specification in this manual at any time without notice.

1. Parts and Functions

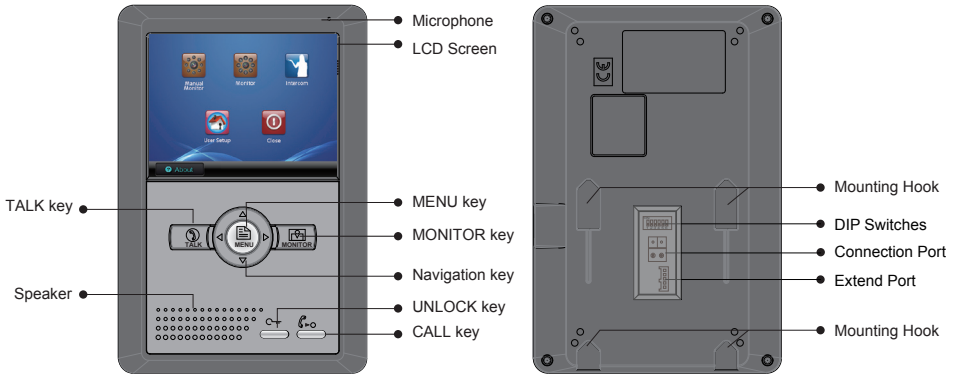

Key Functions

Microphone	Receives sound from the user.
LCD screen	Display the images from outdoor station.Touch operation.
Menu key	Press to open a list of actions available on the current screen.
Monitor key	Press to view the outside condiction.
Navigation key	Scrolls through lists and moves the cursor . Also adjust the ringer volume.
Unlock key	Press to release the door for visitors during talking or monitoring.
Call key	Press to activate the intercom function page.
Talk key	Press to talk with the visitors while receiving a call.
Speaker	Output sound from the outdoor.

2. Monitor Mounting

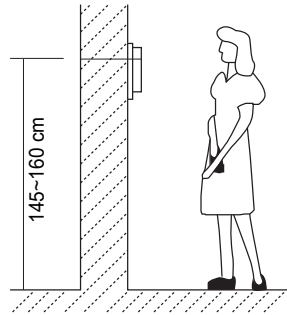
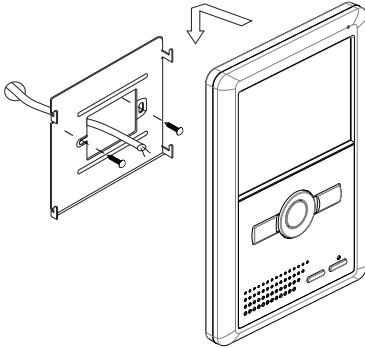

- Use the screws to fix the Mounting Bracket on the wall.(accessories include a Bracket, two 4X25 screws (use to fasten the Mounting Bracket), 2 wire cables (use to connect with Monitor)).
- Connect the system correctly. then hang the Monitor on the Mounting Bracket firmly.

3. About Home screen

The Home screen is your starting point for using all the applications on your monitor. You can customize your Home screen to display applications, logos, and languages.

To open the home screen page, tap  Menu key twice on the monitor or press the LCD screen anywhere twice.

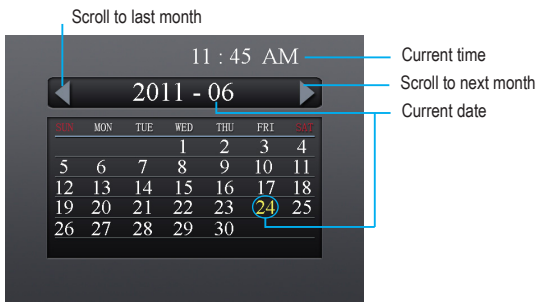

Calendar





Home screen

Tap any icon to start using the application



4. Basic Function Instructions

Answering a Door Call





When you receive a call, the monitor will ring, at the same time ,the visitor's image will be seen on screen.(Note:the screen will turn off after 30 seconds if nobody answers.)

Press **TALK**  Button or touch  icon, you can talk with the visitor for 90 seconds. During talking state, press the **TALK** Button again or press  icon to end the conversation. If the system connects two or more Monitors, pick up any Monitor , others will automatically shut off.

Door Release





During the conversation, press **UNLOCK**  Button or touch  icon to open the door.(if two locks are connected to door camera,touch unlock 2nd icon to release the second lock)

Entrance Monitoring

Press **MONITOR**  button on monitor in standby mode,or touch **Monitor**  icon on home screen.the screen will display the view of the outdoor station. During monitoring, touch  **Select Camera** icon to get into the camera switching mode, (or directly touch **Manual Monitor**  icon on home screen), if multi door stations are installed, you can press the camera 1/2/3/4 to monitor the Door Station or CCTV camera you want. Press **Home**  icon to return to home screen page.



Intercom Function

Intercom Call by namelist:User in one apartment can call other apartments in the system. Press **CALL**  button on monitor in standby mode or touch **Intercom**  icon on home screen page ,then select **Intercom by Namelist** item (the namelist will be created automatically by the system). Select a name on the screen then touch **Dial Number**  icon to call.Press  /  icon to enter last/next name list page.(Note:1. Press "CALL" button or touch Dial Number again to redial. 2. Touch icon to cancel the call.)

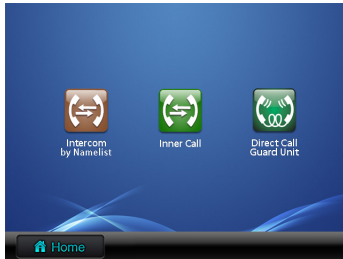

Inner Call: If multi Monitors are installed in one user, select and press the Inner Call item, the other Monitors will ring at the same time, whichever Monitor answers the call, conversation is started, and the other monitors will stop ringing at the same time.

Direct Dial Guard unit: A Monitor can be assigned as Guard Unit Monitor; when the Guard Unit Monitor answers the call, conversation with the guard person is started.



5. Basic Setup Instructions

Ring Tone Setting

Total 12 pieces ring tones can be selected.

You can set different ring tones to identify different calls from Door Station call, Intercom call or Door Bell call.

To open ring tone setting page:

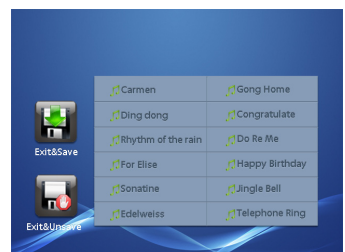

1. On the home screen, touch **User Setup**  icon.
2. Touch **Door Station call tone/Intercom call tone/Door Bell call tone**.
3. Choose a ring tone you want, then touch  icon to save and exit, the ring tone will be performed immediately. Or touch  icon to unsave and exit.



Ring Volume Setting

You can set a ring volume for day time, 6:00 AM~18:00 PM is the day time by default.

To open ring volume setting page:



1. On the home screen, touch **User Setup**  icon.
2. Touch **Ring Volume** item.
3. Touch **Adjust+** to increase the volume or touch **Adjust-** to decrease the volume.
4. Touch  icon to save and exit, the setting will be performed immediately.



Night Ring Volume Setting

You can active a ring volume for night time, 18:00 PM~6:00 AM is the night time by default.

To open night ring volume setting page:

1. On the home screen, touch **User Setup**  icon.
2. Touch **Night Ring Volume** item.
3. Touch **Adjust+** to increase the volume or touch **Adjust-** to decrease the volume.
4. Touch  icon to save and exit, the setting will be performed immediately.







Note: If you adjust the volume to 0, **mute function** will be activated. It's very useful when you don't want to be disturbed.

Monitor Time Setting

90 seconds is the default monitor time. But you can change the value at any time.



To open monitor time setting page:

1. On the home screen, touch **Manual Monitor**  icon.
2. Touch **Monitor Time** item.
3. A digital keypad will be shown, touch the keypad to input the setting.
4. Touch  key to cancel the input, and touch  key to save the setting.
5. Touch **Cancel**  button to return last page.



Screen Setting

To open screen setting page:



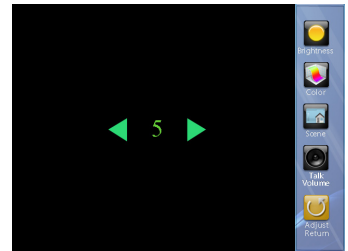

1. When the Monitor is in monitoring or talking state, Press **Adjust**  icon.
2. Touch **Brightness/Color/Scene/Talk volume** item.
3. Touch  /  icon to decrease or increase the value. Settings will be performed immediately.



Date and Time setting

You can reset the date and time shown on the calendar page.

To open clock setting page:

1. On the home screen, touch **User Setup**  icon.
2. Touch **Clock** item.
3. Touch the digital keypad to input the correct time.
4. Touch  key to cancel the input, and touch  key to save the setting.
5. Touch **Cancel**  button to return last page



Restore to default setting

The restore to default function allows the user to recover the settings to factory setting. Note that this operation is irreversible and will not change the time setting.

To open restore to default setting page:

1. On the home screen, touch **User Setup**  icon.
2. Touch **Restore to default** item, a message of "Restore to default?" will be asked.
3. Touch **Restore to default** button again, setting will be performed.



6. Monitor Parameter Setting

You can set the parameter setting on monitor directly.

To open Installation setting page:

1. On the home screen, touch **About**  icon. Some informations about the monitor will be shown.

2. In this information page, press **Unlock**  button and hold for approximately 3 seconds.

3. A digital keypad and some setting informations will be shown. The setting informations are as right:

[0010] #: Remove all remote control
 [0011] #: Add remote control
 [8000] #: Set as master unit 0
 [8001] #: Set as slaver unit 1
 [8002] #: Set as slaver unit 2
 [8003] #: Set as slaver unit 3
 [8004] #: Set as guard unit
 [8005] #: Set as Not guard unit
 [8006] #: Panel on as slaver unit called
 [8007] #: Panel off as slaver unit called
 [8008] #: Date format:MM/DD/YYYY
 [8009] #: Date format:DD/MM/YYYY
 [8010] #: Set lock mode to 0
 [8011] #: Set lock mode to 1
 [8012] #: 12-Hour system
 [8013] #: 24-Hour system
 [8021]~[8029] #: Set the lock time of 1~9s

How to set the monitor as a Guard Monitor

A Monitor can be assigned as Guard Unit Monitor; when the Guard Unit Monitor answers the call, conversation with the guard person is started..

The code number of 8004 is used to set the monitor as a guard unit monitor and 8005 is used to cancel this function.

How to set the slave monitor address

Maximum 4 monitors can be connected in one apartment, one master monitor together with 3 slave monitors, so you should set the address correctly. (note: must have one monitor to be set as master monitor)

The code of 8000 is used to set the master monitor.

The code of 8001 is used to set the first slave monitor .

The code of 8002 is used to set the second slave monitor .

The code of 8003 is used to set the third slave monitor .

Note: touch * button to cancel the input, touch # to save the settings.

How to set date and time format

The system offers two methods of date and time.

The code number of 8008 is used to set the date format as month/date/year

The code number of 8009 is used to set the date format as date/month/year

The code number of 8012 is used to set the time format as 12 hour system

The code number of 8013 is used to set the time format as 24 hour system

How to set the slave monitor panel on

In default mode,when receive a calling,the master and slave monitors will ring at the same time,and just the master monitor can display the image while the slave monitors can not.But the settings can be changed,you can set the master monitor and all the slave monitors to panel on at the same time when receiving a call, just input the code number of 8006 on each slave monitor.

How to set the unlock parameter

Unlock mode:

There are two unlock modes: 1.power-on- to-unlock type:unlock mode=0(by default)

2.power-off-to-unlock:unlock mode=1.

The code number of 8010 is used to set the unlock mode to 0

The code number of 8011 is used to set the unlock mode to 1

Unlock time:

The unlock time can be changed by yourself at any time.it can be set from 1 to 9 seconds.

The code number from 8021 to 8029 are used to set the unlock time to 1~ 9 seconds.

How to add the remote control function

The DT25TD5 monitor has assigned with remote control function,you can control the monitor via remote control.

The code number of 0010 is used to remove all remote control function.

The code number of 0011 is used to add remote control function.

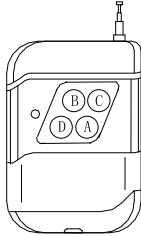

Button functions of Remote control

A: Monitor/Talk button

B: Reserve



C: Reserve

D: Unlock/Confirm button

7. TPC Function

The DT25/TD5 monitor has assigned with TPC function that you can divert calls to the telephone. For more detail information, please refer to TPC user manual.

To open TPC function page:

1. On the home screen, touch **User Setup**  icon.
2. Touch **TPC**  icon
3. Three telephone numbers are available, input numbers by touching the digital keypad.

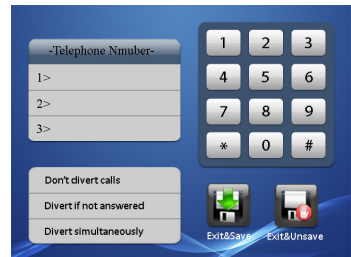

8. Specification

Power supply for indoor monitor:	DC 24V
Power consumption:	Standby15mA; Working 400mA
Monitor screen:	5 Inch digital color LCD
Display Resolutions:	640*3(R, G, B) x 480 pixels
Video signal:	1Vp-p, 75Ω, CCIR standard
Wiring:	2 wires, non-polarity
Dimension:	199(H)×135(W)×23(D)mm

