

4. SPECIFICATIONS

- 1) Power supply for indoor monitor: DC 15~18V (supplied by Adaptor)
- 2) Power supply for Door Camera: DC 10~12V (Supplied by Indoor Monitor)
- 3) Power consumption: Standby 0.5W; Working status 15W (for kits)
- 4) Display screen: 7 Inch TFT-LCD with LED backlight
- 5) Display Resolutions: 1,440(R, G, B) x 234 pixels
- 6) Camera Lens: 3.6mm, 72 degree horizontal visual angle
- 7) Camera resolutions: >300 TV lines
- 8) Video signal: 1Vp-p, 75Ω, CCIR standard
- 9) Monitor time: 30 seconds
- 10) Talking time: 90 seconds
- 11) Connection mode: 4 wiring, polar
- 12) Dimensions: 225(W)×155(H)×26(D)mm

5. PRECAUTIONS

- 13) All parts should be protected from violence vibration or dropping.
- 14) Please do the cleanness with soft cotton cloth, please do not use the organic or chemical clean impregnate.
- 15) Image distortion may occur if the video door phone is mounted too close to magnetic field e. g. Microwaves, TV, computer etc.
- 16) Please keep away the video door monitor from wet, high temperature, dust, and caustic and oxidation gas in order to avoid any unpredictable damage.

6. TROUBLE SHOOTING

Phenomenon	Check points
No power	Is the power cord properly inserted in the AC outlet, or the AC is not supplied?
No sound and calling	Make sure that 4B is connected correctly.
No image visible	Is the Brightness or Color correctly adjusted? Make sure that 3Y is connected correctly.
No enough volume	Is the Ring or Talk Volume correctly adjusted?
The image isn't clear	Is the protect cover film on the Door Camera lens removed? Is the Brightness or Color correctly adjusted? Make sure the lens of outdoor camera is clean Make sure the JP-VD jumper is correctly set.

ENGLISH

SINGLE FAMILY VIDEO INTERCOM SYSTEM

VT692 SERIES MONITOR

CONTENTS





1. MONITOR PARTS AND FUNCTIONS
2. OPERATION INSTRUCTIONS
3. SYSTEM WIRING
4. SPECIFICATIONS
5. PRECAUTIONS
6. TROUBLE SHOOTING

FEATURES

*7 INCH TFT-LCD WITH TOUCH SCREEN AND COLOR MEMO
15 CHORD TUNES SELECTABLE, INTERCOM FUNCTION
EXPANDING UP TO 2~4 OUTDOOR STATIONS AND 5 MONITORS*



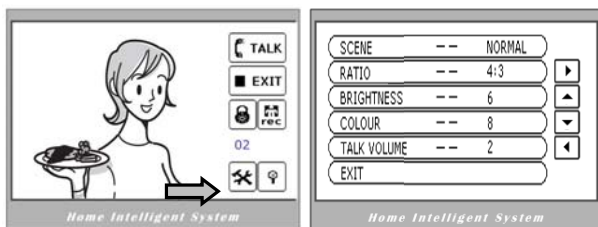

VT-ENG-692MT-V1-2292 080606

2.4. Image and volume adjust operation

- During monitoring or talking, press  icon as right, ADJUST MENU is displayed. if you touch the  icon at bottom right, OSD icons will not display; and OSD icons will be redisplayed if you touch the screen again.
- Touch EXIT item, ADJUST MENU will be shut off.
- Touch the item to be adjusted, then it will be displayed in red color.
- To change the value of the current item, press  /  Icons to increase/decrease.
- Note: Total 4 SCENE modes can be selected in sequence: NORMAL, USER, SOFT and BRIGHT. Whenever you modify BRIGHTNESS or COLOUR, SCENE item will be set to USER mode automatically. RATIO can be shifted from 16:9 to 4:3.



2.5. Basic Setup instructions

- During standby state, touch the screen to display MAIN MENU, then touch and enter SETUP MENU.
- The OUTDOOR CALL and INTERCOM CALL item are for chord ring selection. Use  to select next tune, and use  to replay.
- The RING VOLUME item is for ring volume adjustment, use  /  to increase/decrease.

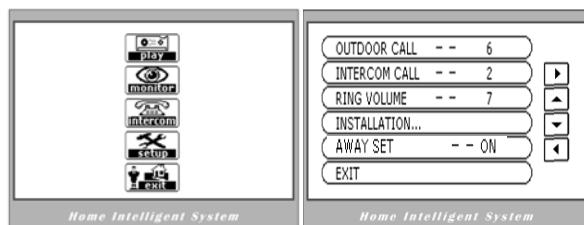

2.6. Installation configurations

- Follow the above steps to enter SETUP MENU, select INSTALLATION... item.
- Input password '2008', and press # icon to enter.
- 1WAY/2WAY MODE item is for the installed Outdoor camera numbers, and should be set to 1/2 according to the 4.3 and 4.4 instructions.
- UNLOCK TIME item is to adjust unlock timing, according to different locks.
- INFORMATION item will display hardware/software version, and power supply voltage. Press RESTORE FACTORY SET to retrieve default, or press any other itmes to exit.

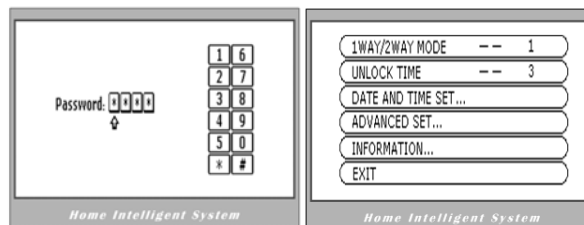

2.7. Operation for Color Memo (Available only for Color Memo model)

Note: The picture can be recorded both manually and automatically. The image capacity is above 120 pcs, and the oldest one will be replaced if the memory is full.

- Manual Record**
When the screen is turned on, in monitoring or talking state, press the REC icon to save current image.
- Automatic Record**
If ABSENT mode is set (see as below) in the Monitor, when Door Station calls, a picture is automatically saved after 2 seconds. If nobody answers the call, IN-USE LED will flashing in red.
- ABSENT Mode**
Follow 2.5 instructions to enter SETUP MENU, then select AWAY SET, touch it once more to toggle to ABSENT(ON) mode, and IN-USE LED will be flashed in Green. However, if you want to cancel, just touch the item to reset.

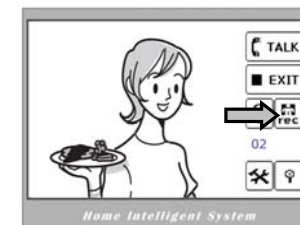

- Playback**
During standby, touch the screen to launch MAIN MENU, then press PLAY icon, the latest picture in the Memory will be showed. Press NEXT/LAST icons to view pictures forward or backward. During the playback, press EXIT icon will exit. If no key was pressed within 30 seconds, the screen will be closed.
- Delete picture**
During playback, press DELE icon, a tip 'DELETE?' will be showed on the upper right of the screen, press DELE icon again to confirm, the current picture will be deleted. However, you can press NEXT/LAST icons to cancel if you don't want to delete.

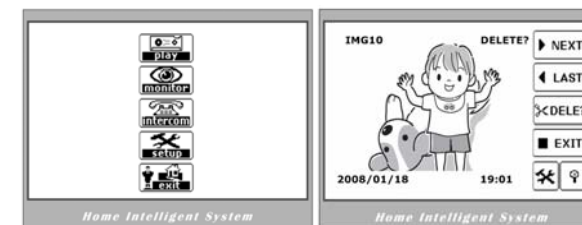

6) Date and time setting

Follow 2.6 instructions to enter INSTALLATIONS..., select DATE AND TIME SET. use the touch screen keypad to input numbers.

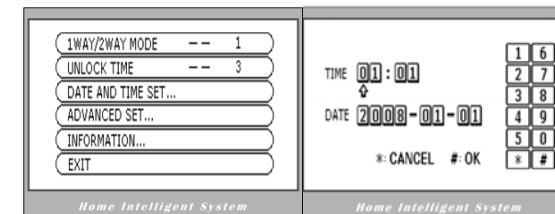

3. SYSTEM WIRING

3.1 Terminals and descriptions as below:

- **1R** Power positive. +12V present when Outdoor Station calling or being monitored.
- **2W** Power negative (GND)
- **3Y** Image signal (Video signal)
- **4B** Talk and control signal (Audio signal)

It's recommended to use RVVP 4x0.3mm² Shielded Cable. And when distance is over 30m, we suggest to use additional coaxial cable SYV- 75-3 (RG-59) connect 3Y and 2W pin.

3.2 Basic 1-1 system wiring drawing

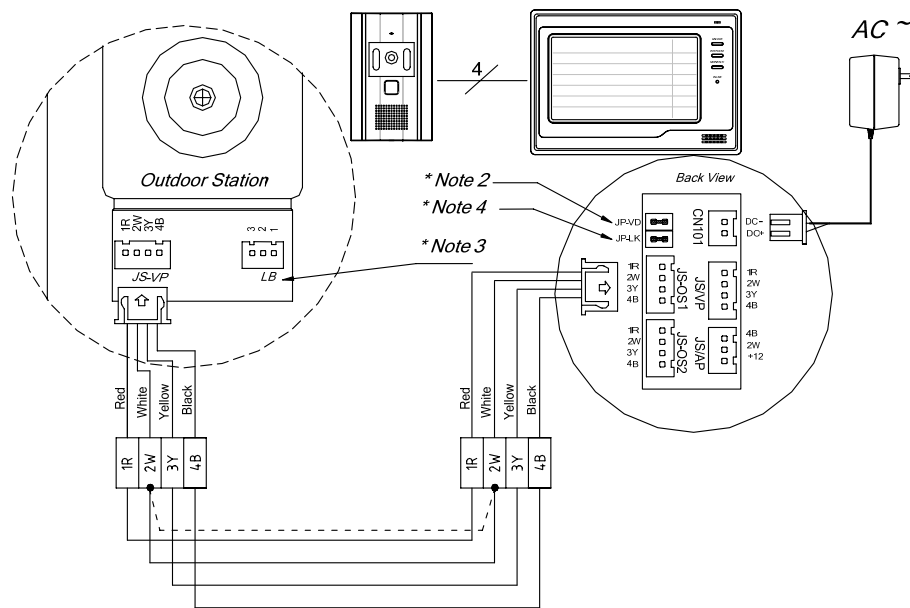

- Note 1: JP-VD is used for setting the video impedance. When there is only one Monitor, keep the jumper (which is already on JP-VD). But when multi Monitors are installed, be sure of taking away all JP-VD of Monitors except only the last Monitor.
- Note 2: LB in Outdoor Station includes 3 wiring Terminals: '1'-Normally Opened Terminal, '2'- Common Terminal, '3'- Normally Closed Terminal. If the latch is activated when powering, connect it between '1' and '2' terminal; if the latch is deactivated when powering, connect it between '2' and '3' terminal.
- Note 3: JP-LK is used for Latch selection, please refer to Outdoor Station manual.

2. OPERATION INSTRUCTIONS

2.1. Basic functions

- 1) When visitor presses the Call Button on the Outdoor Station, the monitor rings, at the same time, the screen displays the visitor image, and IN-USE LED turns to red.
- 2) Then press MON/TALK Button, and you can talk with the visitor for 90 seconds. During talking state, press MON/TALK again to end the conversation. If nobody answers the phone, the screen will be turned off automatically after 30 seconds. If the system connects two or more Monitors, when any Monitor starts to talk, the other Monitors will be automatically shut off.
- 3) When Monitor is standby, press MON/TALK Button, the screen will display the view of the Outdoor Station. During monitoring state, press MON/TALK Button, you can talk with outside through the Outdoor Station, or press again to exit. However, monitoring state is limited to 30 seconds and will be shut off automatically.
- 4) Press Unlock Button to release the Electronic Latch during monitoring or talking.
- 5) However, you can operate by touching the corresponding icons on the screen.

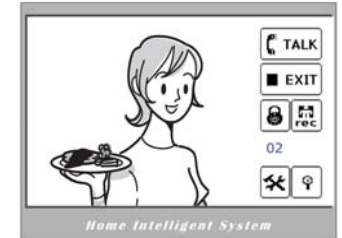

2.2. Operation for multi Outdoor Cameras (If installed)

- 1) All Monitors can monitor on each Outdoor Station in turn. Press MON/TALK Button in standby, the image of the 1st Door Station is displayed firstly. Press MON/TALK again to talk, press MON/TALK to switch to the next Outdoor Station etc.
- 2) During monitoring, press UNLOCK Button to open the door.
- 3) However, you can operate by touching the icons on the screen.

2.3. Intercom function (Available if multi Monitors are installed)

- 1) Intercom can be initiated by any Monitor. Press CALL Button on one Monitor, the other Monitors will ring, and press CALL Button again to redial. If TALK Button is pressed on any other Monitor, intercom talking is started.
- 2) During intercom, press TALK Button to cancel, or it will exit automatically after 30 seconds.
- 3) Intercom function is prior to monitor function, but calling function is always the first.

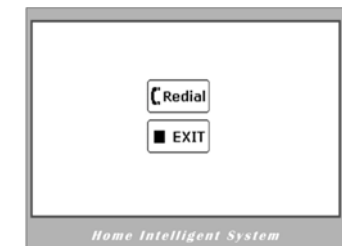

1. MONITOR PARTS AND FUNCTIONS

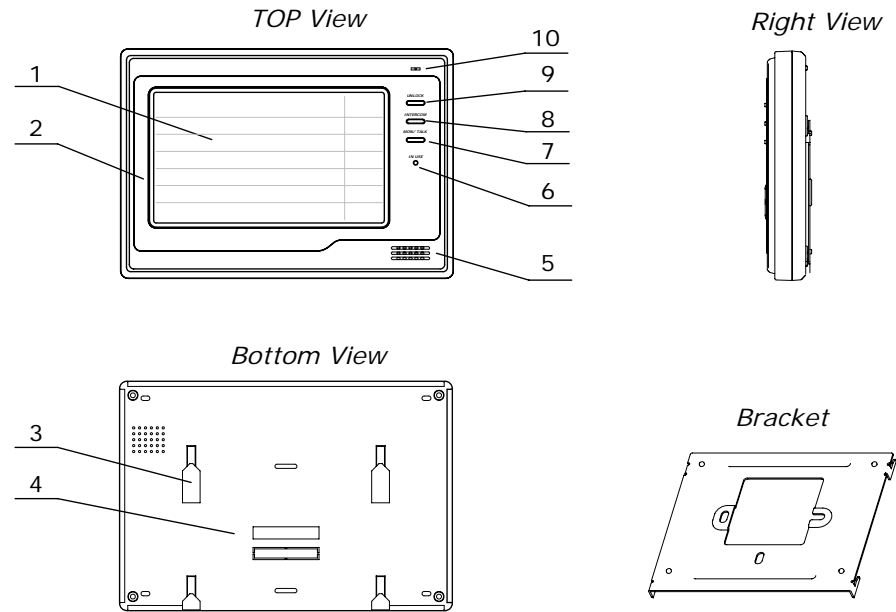

- | | |
|----------------------------------|--------------------------|
| 1. 7 Inch TFT-LCD (Touch Screen) | 6. LED for In-use |
| 2. Screen Frame | 7. MONITOR & TALK Button |
| 3. Mounting Bracket Hold | 8. UNLOCK Button |
| 4. Wiring Terminals | 9. CALL/INTERCOM Button |
| 5. Speaker | 10. Microphone |

Accessory fittings: Bracket (Two 4X25 screws are needed for fastening the Mounting Bracket), Special 4 core cables to connect with Monitor.

Installation steps: The installation height of Indoor Monitor, usually from 145 to 160CM, then fix the bracket on 86 Installation Box or wall surface directly, then install the Monitor.

*The design and specifications can be changed without notice to the user.
Right to interpret and copyright of this manual are preserved.*

3.3 Wiring Diagram of Extensions

