

ENGLISH

# VIDEO DOOR PHONE SYSTEM

---

USER MANUAL

The design and specifications can be changed without notice to the user. Right to interpret and copyright of this manual are preserved.



Read this manual through before installation and(or) doing any operation.

## 8. Specifications

- Power supply for indoor monitor: DC 15~18V (supplied by Adaptor)
- Power supply for Door Station: DC 10~12V (Supplied by Indoor Monitor)
- Audio Phone : DC 10~12V (Supplied by Indoor Monitor)
- Power consumption: Standby 0.5W; Working status 15W (for kits)
- Monitor screen: 7 Inch color TFT-LCD
- Display Resolutions: 1,440(R, G, B) x 234 pixels
- Video signal: 1Vp-p, 75Ω, CCIR standard
- Picture Memo Capacity: 127 PCS
- Wiring: 4 wires, polar
- Monitor time: 30 seconds
- Talking time: 90 seconds
- Dimensions: 155(H)×225(W)×28(D)mm

## PRECAUTIONS !

- Connect this unit **ONLY** to other compatible units. Do not connect it to any other type of alarm or auxiliary device. Connecting anything else to this unit may damage it or prevent it from operating properly.
- Do not place cords from the AC/DC adapters, camera or monitor where they can be pinched or stepped on. Protect the cords by keeping them out of the way of children, pets and routine household traffic. Do not place heavy objects on power cords or cover cords with rugs or carpet.
- Unplug the AC/DC adapters from the wall outlet when the system is not in use.
- Slots or openings in the back of the monitor, are provided for ventilation and to ensure reliable operation of the video monitor or equipment and to protect it from overheating. These openings must not be blocked or covered. The monitor should never be placed near or over a radiator or heat register and should not be placed in a built-in installation such as a bookcase unless proper ventilation is provided.
- All parts should be protected from violence vibration. And not allow be impacting, knocking and dropping.
- For clean the Lens& Screen, using hands or wet cloth is forbidden.
- Please do the cleanness with soft cotton cloth, please do not use the organic or chemical clean impregnate. If necessary, please use a little pure water or dilute soap water to clean the dust.
- Image distortion may occur if the video door phone is mounted too close to magnetic field e. g. Microwaves, TV, computer etc.
- Please keep away the video door monitor from wet, high temperature, dust, and caustic and oxidation gas in order to avoid any unpredictable damage.









## CONTENT

1. Product Features	-----	1
2. Parts and functions	-----	2
3. Mounting and Installation	-----	2
4. Standard System Wiring	-----	3
5. Extending Monitors	-----	4
6. Extending 2 Outdoor Stations	-----	5
7. Operation Instructions	-----	6
8. Specifications	-----	10



** The model you purchased may not have all the functions mentioned here, but the operation is simylar.**

### 7.5 Operation for Picture Memory(optional)

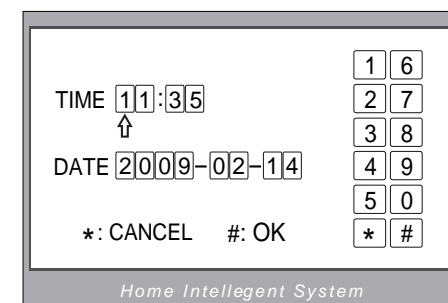
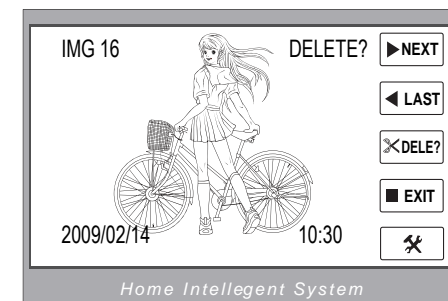
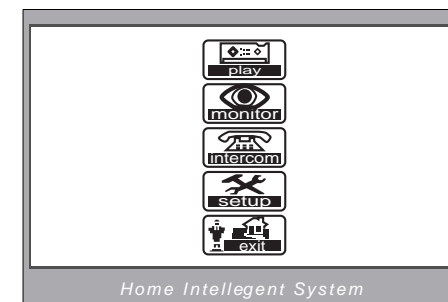
1. The picture can be recorded both manually and automatically. The image capacity is above 120 pcs, and the oldest one will be replaced if the memory is full.
2. Manually record: when the screen is turned on, in monitoring or talking state, touch the  icon (or press the CALL Button) to save current image.
3. Automatic record: enter the SETUP page and turn on the AUTO RECORD item.
4. Playback the pictures: During the standby, touch the screen to enter the main menu, then touch  icon to enter the playback page. The latest picture will be show. touch  /  icon to view forward / backward. Touch the  icon, a 'DELETE?' hint will show on the uper right of the screen, Touch the  icon again to delete the current picture. Please note that the delete operation is irrepeatable.
5. Date and Time setting: Enter the SETUP --> ADVACED SET --> DATE/TIME SET item, the setting page will show as bellow. Touch the keypad on the screen to input the numbers. Touch the # icon(on the number key pad)to save and exit or touch the \* icon to cancel.



## 7.4 Basic Setup Instructions

1. During standby state, touch anywhere on the screen, the date/time page will be displayed. The first line show the current time, the second line shows the current date and weekday. (the date/time page will close in 3 munite if no operation).
2. Touch the screen again to enter the MAIN MENU, press  to enter SETUP MENU.
3. The OUTDOOR TONE and INTERCOM TONE item are for chord ring selection. Touch  /  to increase/decrease the value.
4. AUTO RECORD: If the item is set to ON, the Monitor will record the image automatically in 2 seconds after the visitor pressed the CALL Button on the Outdoor station.
5. The ADVANCED SET...item is for advance settings. a password will be asked before entering. The default password is 2008.
6. Input the password by touching the digital keypad on the screen to enter.
7. The ONE/TWO CAMERA should be set to 2 if 2 Outdoor stations were to be installed.
8. UNLOCK TIME will be adjusted according to different locks.
9. OTHER DEVICE SET: this item is for RLC and REMOTE settings.
10. INFORMATION will show the hardware/software version and voltage info. Press RESTORE TO DEFAULT item will restore all the settings to default.

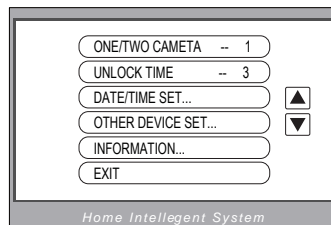
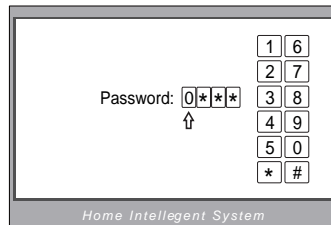
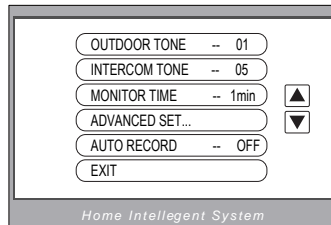
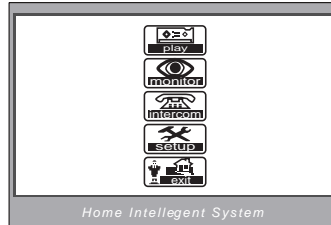
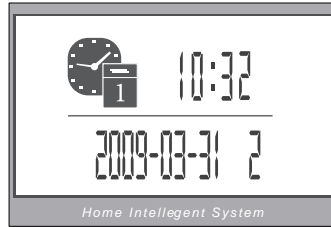

## 1. Product Features

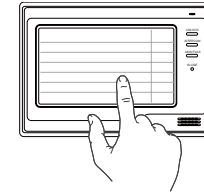

### Touch Screen Operation

All the operations and settings can be done by touching the LCD screen.

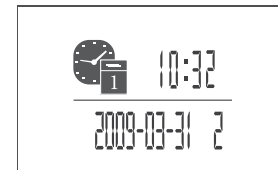

### Full Screen Digital Clock

The date and time will displayed when touch anywhere of the screen, and it will closed automatically after 3 minutes.

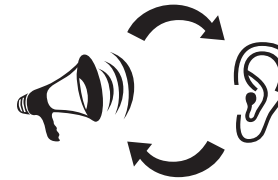

### Press-To-Talk Function

This function will improve the quality of the conversation between Doorstation and Monitor, especially in crowdly environment.



### AUTO Picture Memory(optional)

When the house owner is out off home, the Monitor can record the visitors pictures, you can check who has called later on.

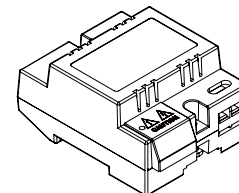

### RLC Control Unit(not included)

You can connect a additonal e-lock or light by the RLC unit, and control them on the monitor.

## 2. Parts and Functions

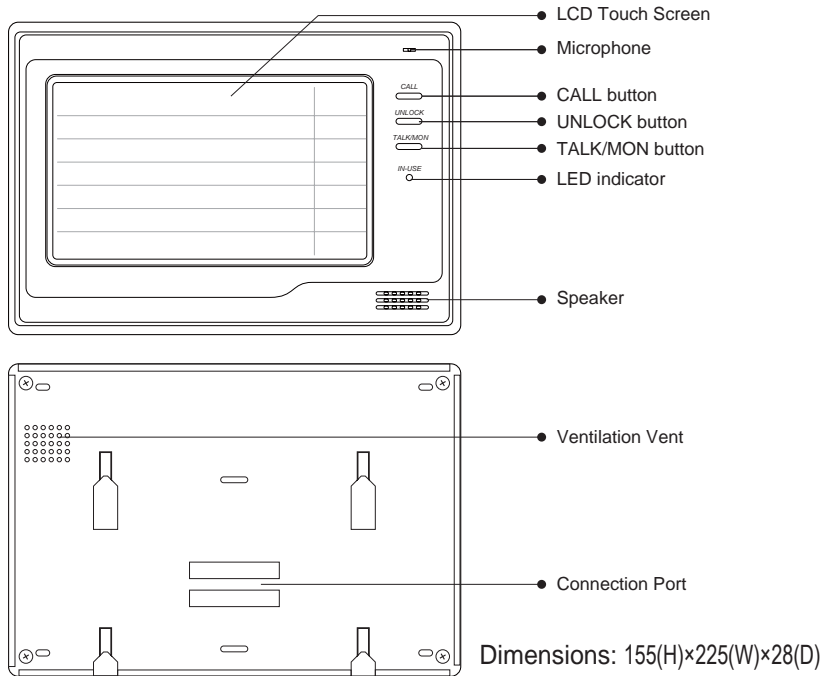

## 3. Mounting and Installation

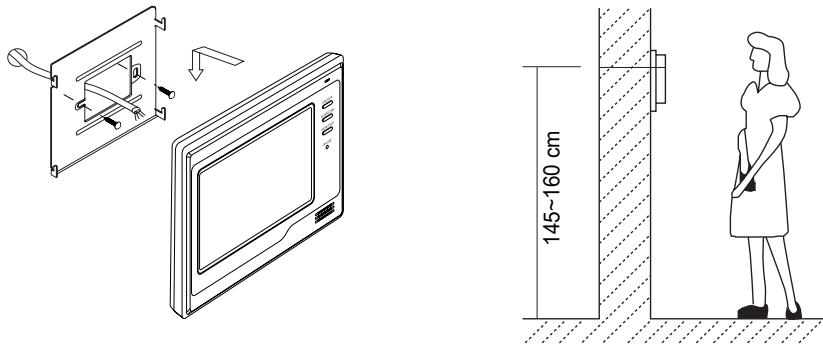



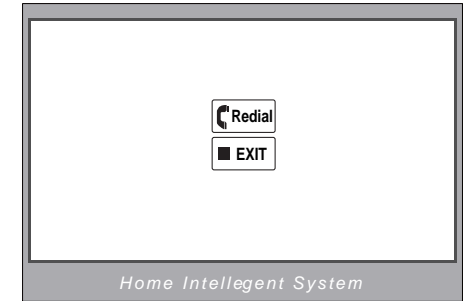

1. Use the screws to fix the Mounting Bracket on the wall.(fitting accesories includes a Bracket (Two 4X25 screws are needed for fastening the Mounting Bracket), Special 4 core cables to connect with Monitor)
2. Wire the system correctly(see the later connection chapter) then hang the Monitor on the Mounting Bracket firmly.

## 7.2 Intercom function(available when Multi Monitors installed)

1. Intercom can be initiated by any Monitor. Press CALL Button on one Monitor, the other Monitors will ring, and press CALL Button again to redial. If TALK/MON Button is pressed on any other Monitor, intercom talking is started.
2. During intercom, press TALK/MON Button to cancel(or touch **EXIT** ), or it will exit automatically after 30 seconds.
3. Intercom function is prior to monitor function, but calling function is always the first.







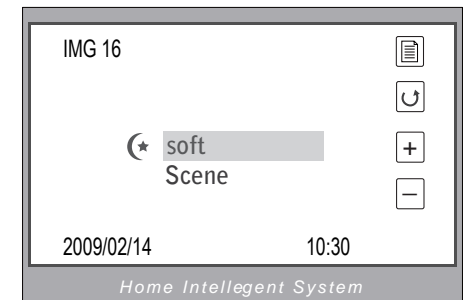
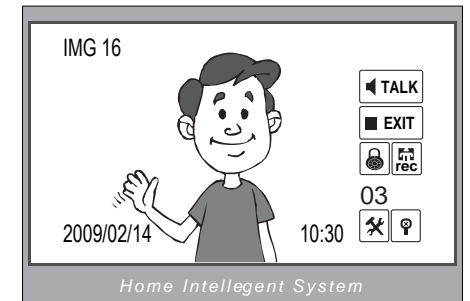







## 7.3 Image and Volume adjustments

1. During monitoring or talking, press  icon, ADJUST MENU will be displayed.
2. Touch the  /  icons to increase or decrease current value; touch the  icon to switch to the next adjustment item.
3. The first item is Scene mode selection: Total 4 SCREEN modes can be selected in sequence: NORMAL, USER, SOFT and BRIGHT. Whenever you modify BRIGHTNESS or COLOUR, SCENE item will be set to USER mode automatically.
4. RATIO can be shifted from 16:9 to 4:3.
5. The BRIGHTNESS and COLOR item is for the image quality setting, adjust the value to get the best image you like.
6. The Ring Volume and Talk Volume items are for ring tone and talking volume adjust.
7. Note that all the modifications will be done immediately after the operation. Touch the  icon to exit out the setting.



## 7. Operation Instructions

### 7.1 Basic Video Door Phone Functions

- When visitor presses the Call Button on the Outdoor Station, the monitor rings, at the same time, the screen displays the visitor image, and IN-USE LED turns to red.
- Press TALK/MON Button(or touch ), you can talk with the visitor for 90 seconds. During talking state, press TALK/MON Button (or touch ) to end the conversation. If nobody answers the phone, the screen will be turned off automatically after 30 seconds.
- Press-To-Talk:** When the normal talk is started, press  to enter Press-To-Talk state, and you will in Listening state by default, press  /  to toggle between Speaking state and Listening state. Press  to exit Press-To-Talk state and return to normal talking state.
- When Monitor is standby, press TALK/MON Button(or touch anywhere on the screen, then touch ) , the screen will display the view of the Outdoor Station. During monitoring state, press TALK Button(or touch ) , you can talk with outside through the Outdoor Station, or press again to exit. However, monitoring state is limited to 30 seconds and will be shut off automatically.
- During the monitoring, press UNLOCK Button(or touch ) to release the Electronic Lock,press the CALL Button(or touch ) to record the current picture. Touch  will show the creen settings.
- Touch the  icon will hide all the icons on the screen, touch anywhere on the screen again, the icons will showed up.

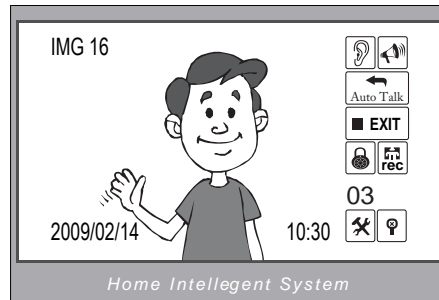
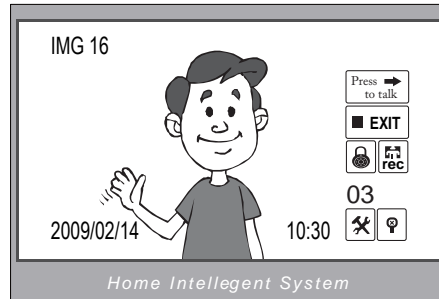
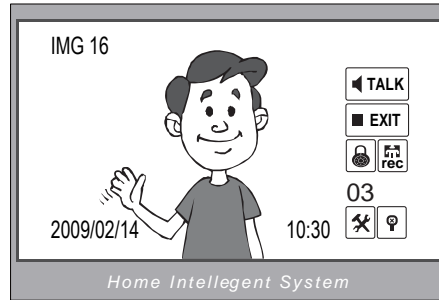

## 4. Standard System Wiring

### Terminal Discriptions:

- **1R** Power positive. +12V present when Door Station calling or being monitored
- **2W** Power negative (GND)
- **3Y** Image signal (Video signal)
- **4B** Talk and control signal (Audio signal)

It's recommended to use RVVP 4x0.3mm<sup>2</sup> Shielded Cable. And when distance is over 30m, we suggest to use additional co-axle cable SYV- 75-3 (RG-59) connect 3Y and 2W pin.

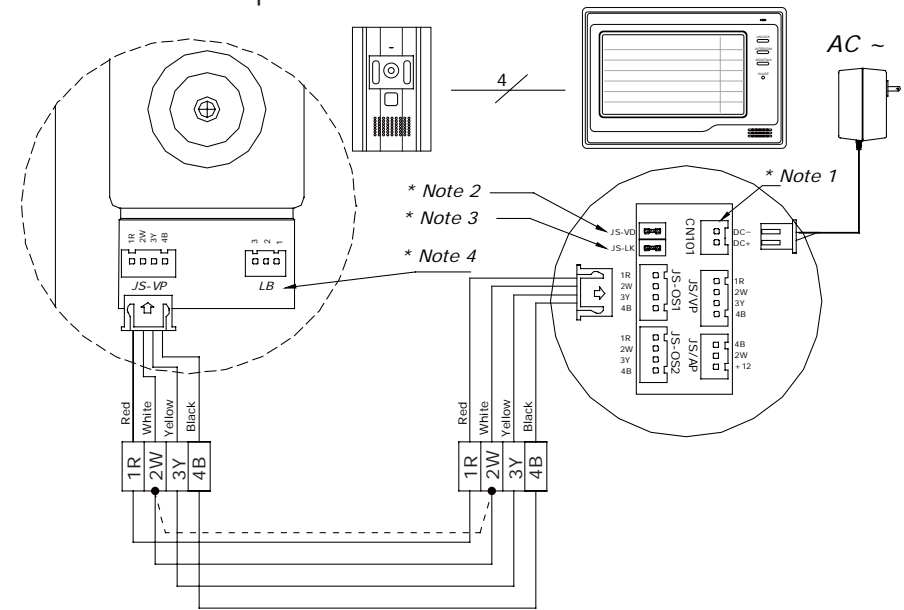

- **Note 1:** Plug the AC Adaptor to the AC power socket properly.
- **Note 2:** JS-VD is used for setting the video impedance. When there is only one Monitor, keep the jumper (which is already on JSP-VD). But when multi Monitors are installed, be sure of taking away all JS-VD of Monitors except only the last Monitor.
- **Note 3:** JS-LK is used for Lock selection, remove the jumper if use the Monitor power to supply the Lock. Refer to the Outdoor station manual.
- **Note 4:** LB includes 3 wiring Terminals: '1'-Normally Opened Terminal, '2'- Common Terminal, '3'- Normally Closed Terminal. If the Lock is activated when powering, connect it between '1' and '2' terminal; if the Lock is activated when power-off, connect it between '2' and '3' terminal.

## 5. Extending Monitors

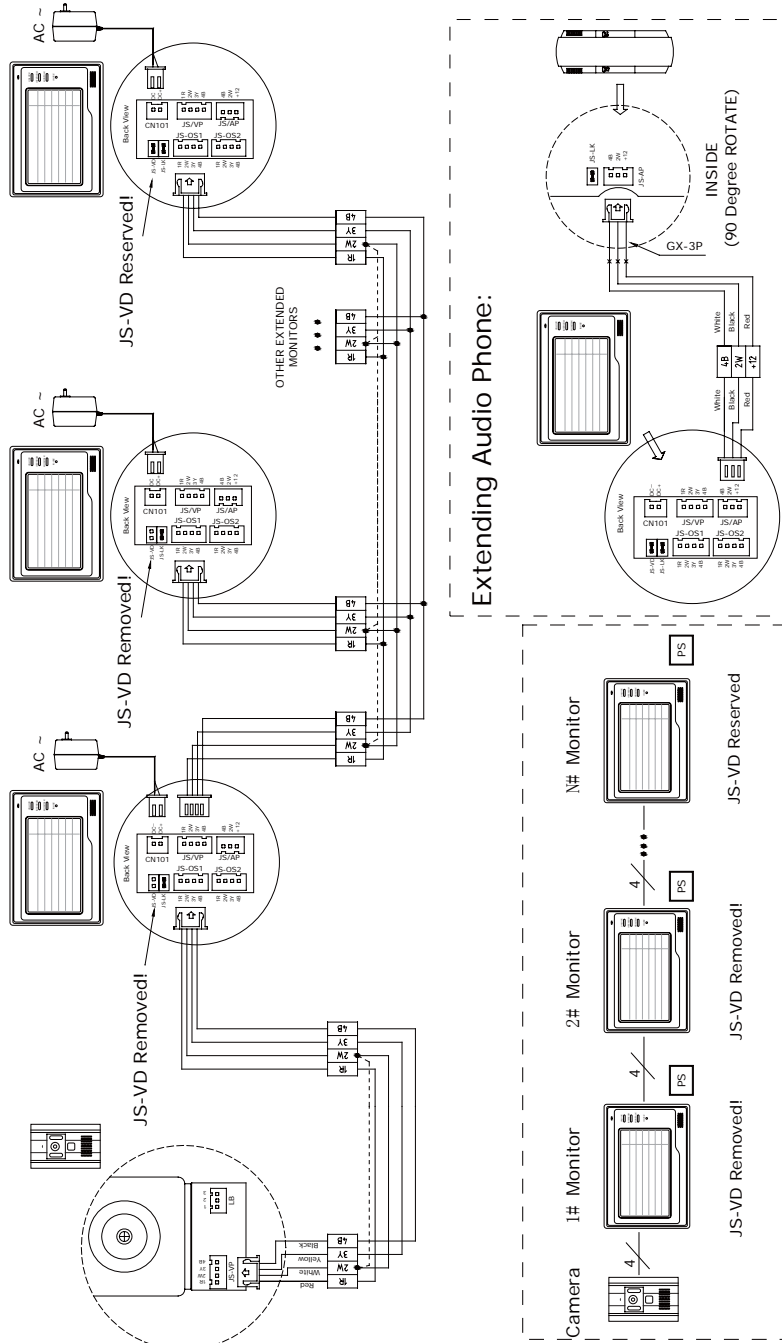

## 6. Extending 2 Outdoor Stations

