

ENGLISH

2 WIRE INTERCOM SYSTEM

USER MANUAL

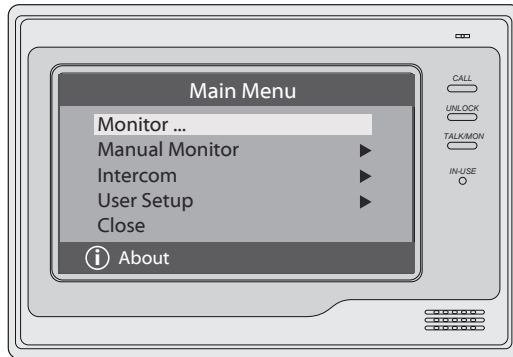

DT-ENG-692TD7-V1

1. Parts and Functions

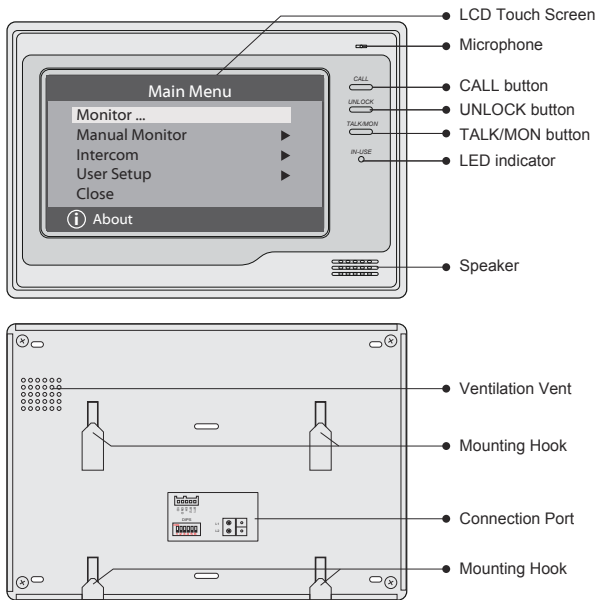

2. Monitor Mounting

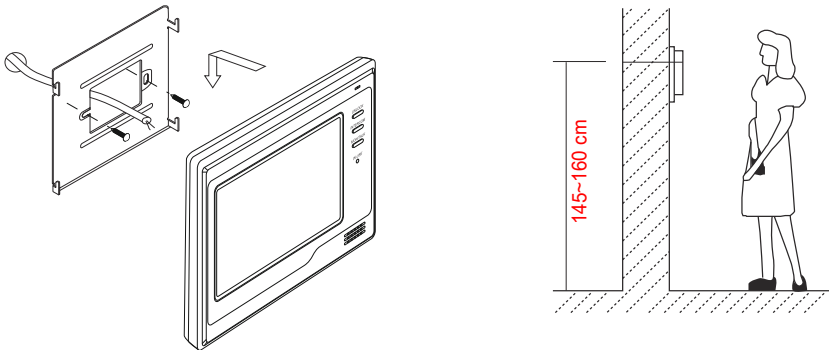



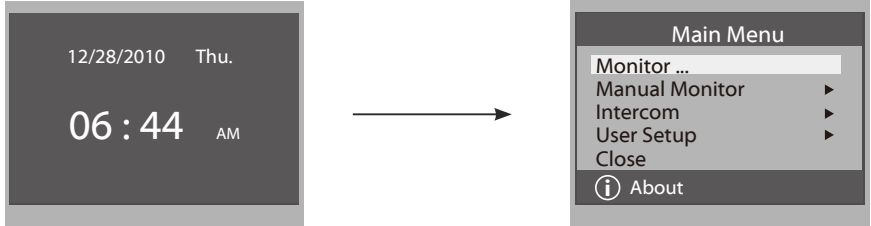

1. Use the screws to fix the Mounting Bracket on the mounting box.(fitting accessories includes a Bracket (Two pieces of 4X25 screws are needed for fastening the Mounting Bracket), Special 2 wire cables to connect with Monitor)
2. Wire the system correctly(see the later connection chapter) then hang the Monitor on the Mounting Bracket firmly.

3. Main Menu

1. Touch the screen anywhere on monitor in standby mode, the date/time page will be showed. (the date/time page will be closed in 1 minute if no operation)
2. Touch the screen again, main menu page will be showed as follows.



4. Basic Door Release Operation

1. Press **CALL** button on outdoor station, the Monitor rings, at the same time, the screen displays the visitor image.
2. Press **TALK/MON** Button on monitor or touch  icon on screen, you can communicate hands free with the visitor for 90 seconds. After finishing communication, press **TALK/MON** button again or touch  icon to end the communication. If nobody answers the phone, the screen will be turned off automatically after 30 seconds.
3. During talking state, Press **UNLOCK** Button or touch  or  icon to open the corresponding door for the visitor.
4. When the monitor is in standby mode, press **TALK/MON** Button (or touch **Monitor ...** item on main menu page), The screen can display the view of outside. If multi door stations are installed, touch  icon to get into the camera switch mode (or direct touch **Manual Monitor** item on main menu page). You can touch camera 1/2/3/4 to monitor the door station or CCTV camera you want. See the following diagrams. (Press **TALK/MON** button again to end monitoring.)



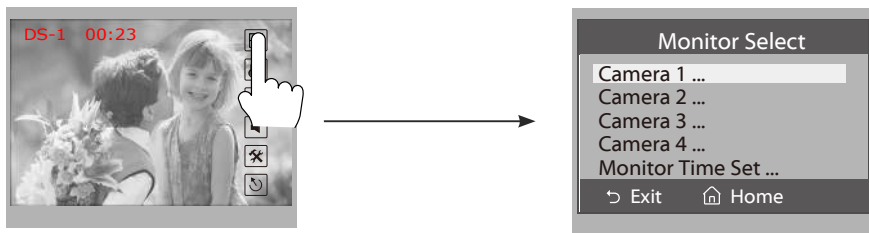

5. Intercom Function

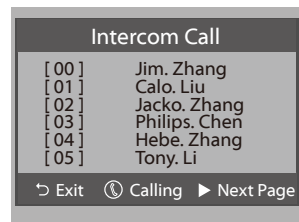
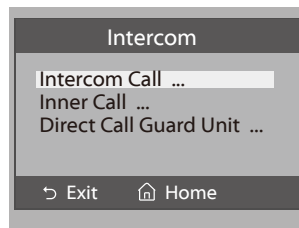

When the monitor is in standby mode, press **CALL** Button to enter Intercom Function page(or direct touch **Intercom** item on main menu page).

- Intercom Call:** User in one apartment can call other apartments in the system. the namelist will be created automatically by the system. Touch a name you want on the screen, then touch ☎ icon or press **CALL** Button on monitor to dial.(Note:1. touch ☎ icon or press CALL button again to redial. 2. Press TALK/MON button to cancel the call. 3.The DIP switches code of each monitor must set different.)
- Inner Call:** If multi Monitors are installed in the same apartment, select Inner Call, all the other Monitors will ring at the same time, whichever Monitor answers the call, conversation is started.and the other monitors will stop ringing at the same time.(note:the DIP switches setting of all monitors must be same.)
- Direct Dial Guard unit:** A Monitor can be assigned as Guard Unit Monitor; when the Guard Unit Monitor answers the call, conversation with the guard person is started..



6. Basic Setup Instructions

Ring Tone Settings

Touch **User Setup** item on main menu page to enter setup page. Touch **Door Station Call Tone**, **Inercom Call Tone** or **DoorBell Tone** item, There are 12 pieces ring tones can be selected. touch a ring tone you want, then touch  icon to save and exit. (touch  icon to cancel the setting and return last page, touch  icon to get into main menu page)

Door Station Call Tone: set the ring tone calling from outdoor station.



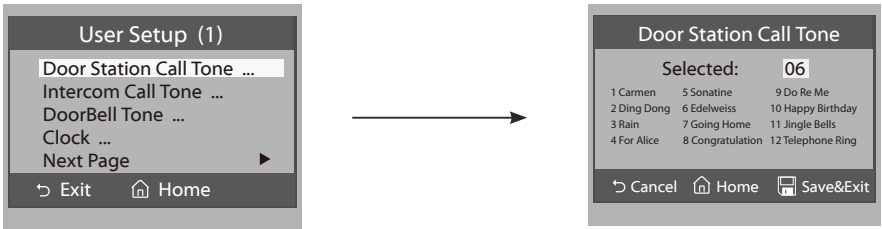

Inercom Tone: set the ring tone calling from other apartments.

DoorBell tone: set the ring tone calling from door bell.





Ring Volume and Night Ring Volume Setting

You can set a ring volume for day time and night time individually, 6:00 AM~18:00 PM is the day time and 18:00 PM~6:00 AM is the night time by default, if you don't want to be disturbed at night, you can set the night ring volume to 0.

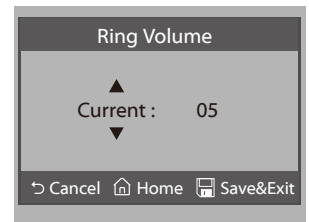
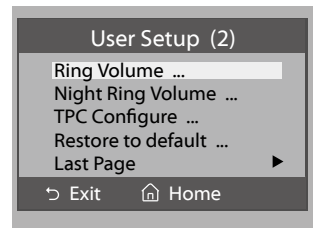
Touch **User Setup** item on main menu page to enter setup page, then touch **Next Page** item to enter User Setup 2 page, select **Ring Volume Setting** or **Night Ring Volume** item. then touch  /  icon to increase / decrease the value; After finish, touch  icon to save and exit. (touch  icon to cancel the setting and return last page, touch  icon to get into main menu page)





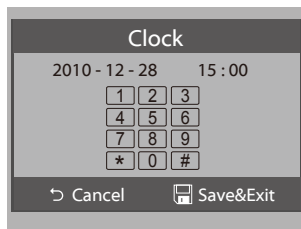

7. Date and Time Setting

Touch **User Setup** item on main menu page to enter setup page, touch **Clock...** item. a digital keypad will be showed on screen, input date and time by touching the digital keypad, use * icon to move the location. After finish, touch  icon to save and exit. (touch  icon to cancel the setting and return last page.)



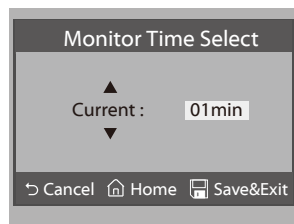

8. Monitor Time setting

Touch **Manual Monitor** item on main menu page to get into camera switch mode, select **Monitor Time Set...** item. touch  /  icon to increase / decrease the value; After finish, touch  icon to save and exit. (touch  icon to cancel the setting and return last page, touch  icon to get into main menu page)



9. Restore to Default

Touch **User Setup** item on main menu page to enter setup page, then touch Next Page item to enter User Setup 2 page, touch **Restore to default** item, a message will be asked to confirm the restore operation. If touch  icon, All settings will be restored to default, if you don't want to restore, touch  icon to cancel the operation. (Note that the restore to default operation will not change the time setting and the datas.)

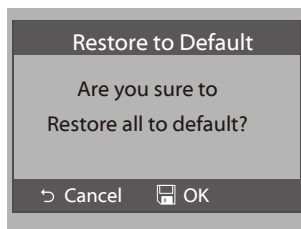
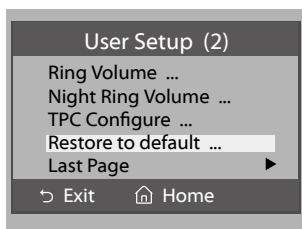

10. Unlock Parameter Setting

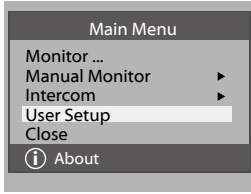

1. Touch User Setup item on main menu page.

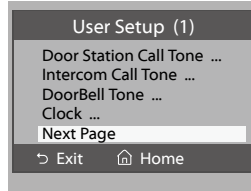

2. Touch Next Page item to enter next page menu.

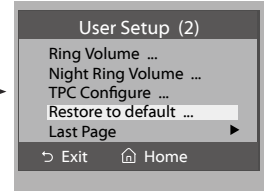

3. Touch Restore to default item, a message will be asked.

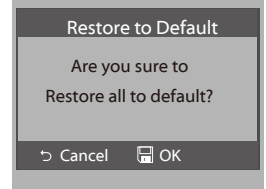

4. Press the UNLOCK button on monitor and hold for 2s.

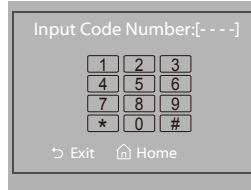

5. Input 4 digits code number by touching the digital keypad. ("*":cancel the input,"#":save the setting)

Note:

8010 is used to set the unlock mode to 0. 8011 is used to set the unlock mode to 1.

11. Screen and Volume Adjustment

During monitoring or talking, touch  icon, the **ADJUST MENU** will be displayed. select the adjustment item you want; touch  /  icon to decrease / increase the value.

1. The first item is Scene mode selection: Total 4 screen modes can be selected in sequence: **Normal**, **User**, **Soft** and **Bright**. Whenever you modify **Brightness** or **colour**, **Scene** item will be set to **User** mode automatically.

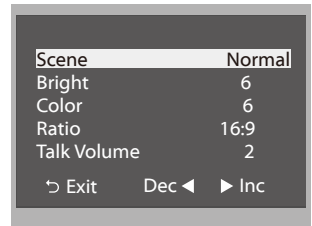

2. The **Brightness** and **Colour** item is for the image quality setting, adjust the value to get the best image you like.

3. The **Ratio** item is for screen display adjustment, you can set to 16:9 or 4:3.

4. The **Talk Volume** item is for talking volume adjustment.

5. Note that all the modifications will be performed immediately after the operation. Touch  icon to exit the adjust page.

12. Specification

- Power supply for indoor monitor: DC 24V
- Power consumption: Standby 1.5W; Working status 10W
- Monitor screen: 7 Inch digital color LCD
- Display Resolutions: 800*3(R, G, B) x 480 pixels
- Video signal: 1Vp-p, 75Ω, CCIR standard
- Wiring: 2 wires, non-polarity
- Dimension: 155(H) × 225(W) × 28(D)mm

DT-ENG-692TD7-V1

The design and specifications can be changed without notice to the user. Right to interpret and copyright of this manual are preserved.